

1 & 1/4 BOWL SINK

MODEL KINGS CROSS



MADE
IN EUROPE



30 YEAR
WARRANTY



FLUSHMOUNT



UNDERMOUNT



TOP MOUNT

PRODUCT INFORMATION

FINISH

- AISI 304 polished finish stainless steel, 1mm thick

SIZE

- Size: 590 X 450 mm
- Bowl 1 size: 1- 340 x 400mm
- Bowl 1/4 size: 170 x 400 mm
- Bowl 1 depth: 215mm (no drain)
- Bowl 1/4 depth: 215mm (no drain)
- Cutout: 565 X 400 mm
- Minimum cabinet size: 600 mm

AVAILABLE ACCESSORIES:



B20.42
chopping board



CS16.39
colander



B30.42
chopping board



EAN 9347777002655

AR18062021

DISCLAIMER

Eurolinx PTY LTD, is continually seeking ways to improve the design specifications, aesthetics and production techniques of its products. As a result alterations to our products and designs take place continually. Whilst every effort is made to produce information and literature that is up to date, this brochure should not be regarded as an infallible guide to the current specifications, nor does it constitute an offer for the sale of any particular product. Product dimensions indicated in our literature is indicative only. Actual product only should be used to define dimension cut outs. Distributors, and retailers are not agents of Eurolinx and are not authorized to bind Eurolinx by any express or implied undertaking or representation.

FOLLOW US ON:



[instagram.com/artusi_appliances](https://www.instagram.com/artusi_appliances)



www.linkedin.com/company/eurolinx-pty-ltd-t-a-lve/

Australia National Telephone Number 1300 (694 583) New Zealand Telephone Number 64 3 344 5913
Artusi showroom hours: Tuesday to Friday - 9am-5pm, Saturday - 10am-4pm, Sunday and Monday - closed
* Melbourne showroom hours: Tuesday to Saturday - 10am-4pm

[artusi.com.au](https://www.artusi.com.au)

NSW & ACT (Head Office)
48-50 Moore Street
Leichhardt
F 02 8569 4699

VIC & SA
1211 Toorak Road
Camberwell
F 03 9809 2155

QLD
1/42 Cavendish Road
Coorparoo
F 07 3397 0850

New Zealand
PO Box 11,160
Sockburn Christchurch
F 03 344 5906

1 & 1/4 BOWL SINK

MODEL KINGS CROSS

TECHNICAL DIAGRAM

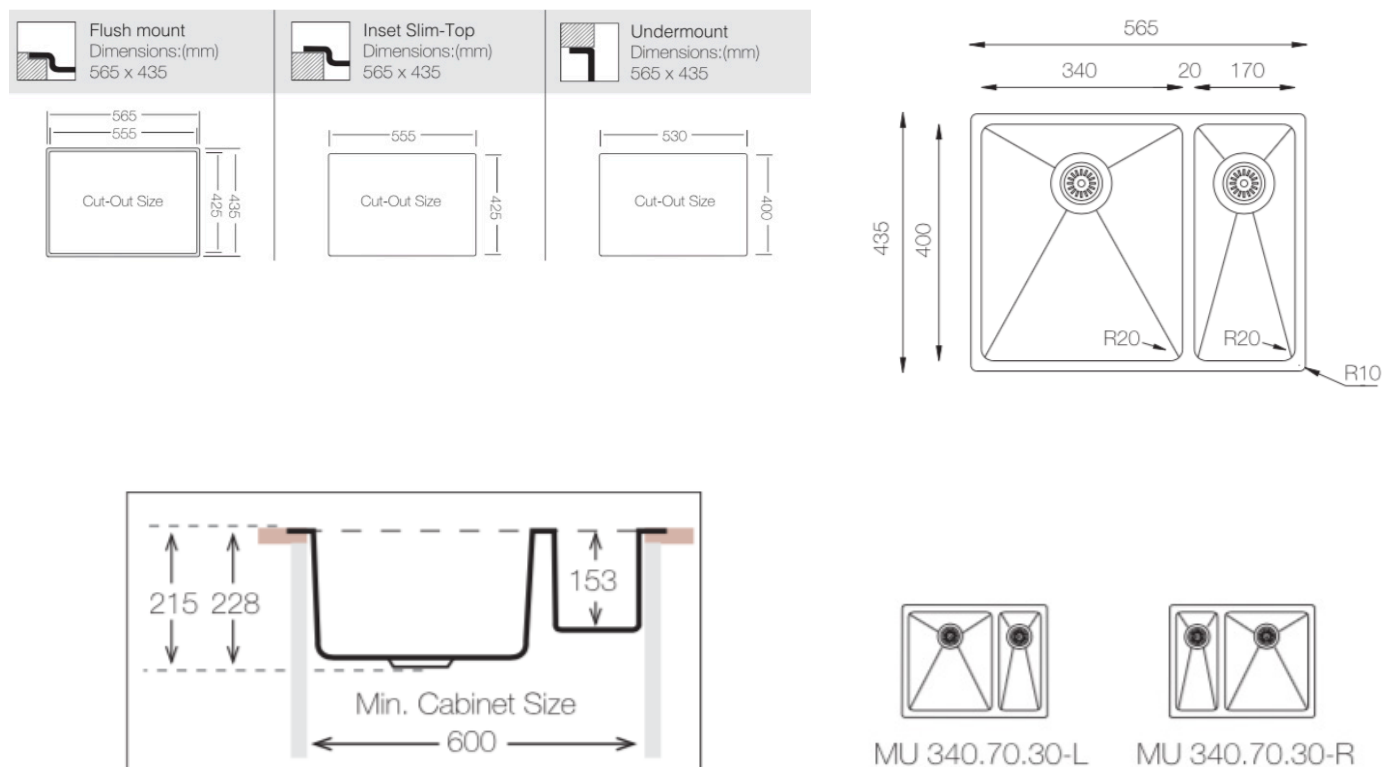

NB: drawings are not to scale — they are to be used for detailed installation instructions, please refer to user guide.

EAN 9347777002655

AR18062021

DISCLAIMER

Eurolinx PTY LTD, is continually seeking ways to improve the design specifications, aesthetics and production techniques of its products. As a result alterations to our products and designs take place continually. Whilst every effort is made to produce information and literature that is up to date, this brochure should not be regarded as an infallible guide to the current specifications, nor does it constitute an offer for the sale of any particular product. Product dimensions indicated in our literature is indicative only. Actual product only should be used to define dimension cut outs. Distributors, and retailers are not agents of Eurolinx and are not authorized to bind Eurolinx by any express or implied undertaking or representation.

KINGS CROSS 1 & 1/4 bowl sink

AISI 304 polished finish stainless steel, 1mm thick

FOLLOW US ON: [instagram.com/artusi_appliances](https://www.instagram.com/artusi_appliances)

www.linkedin.com/company/eurolinx-pty-ltd-t-a-llve/

Australia National Telephone Number 1300 (694 583) New Zealand Telephone Number 64 3 344 5913
Artusi showroom hours: Tuesday to Friday - 9am-5pm, Saturday - 10am-4pm, Sunday and Monday - closed
* Melbourne showroom hours: Tuesday to Saturday - 10am-4pm

[artusi.com.au](https://www.artusi.com.au)

NSW & ACT (Head Office)
48-50 Moore Street
Leichhardt
F 02 8569 4699

VIC & SA
1211 Toorak Road
Camberwell
F 03 9809 2155

QLD
1/42 Cavendish Road
Coorparoo
F 07 3397 0850

New Zealand
PO Box 11.160
Sockburn Christchurch
F 03 344 5906