

ILVE COMMERCIAL

MULTI-RESIDENTIAL & HOME BUILDER PRODUCT RANGE

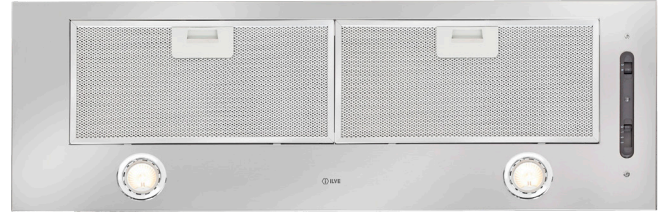

CU89-90 90CM CONCEALED RANGE HOOD

MADE
IN ITALY24 MONTH
WARRANTY90CM
WIDELOW
NOISESPACE
SAVINGHALOGEN
GLOBE

CU89-90 CONCEALED HOOD

FEATURES

- Concealed design built into the kitchen cabinetry
- Suitable for all ILVE cooktops 60cm-90cm wide
- Slider extraction control
- Halogen lighting
- AS304 stainless steel construction

SAFETY

- Motor cut out fire protection

CLEANING

- Filter cleaning in warm soapy water

FILTERS

- Honeycomb aluminium filters

MOTOR

- Max. gross air flow (m³/h): 1200
- Noise (dB): low 35 - high 62
- Three speed
- Twin turbine high velocity centrifugal fan, optional in-line motor is available to assist air flow

DETAILED INFORMATION

- Size: 60cm, 70cm and 90cm
- Colour: Stainless Steel
- Ducting size: 150mm

OPTIONAL EXTRA

- x 2 Charcoal filters: R216007
- Frame: R01087

Range hood extraction rate m³/hr reading is measured at 1m duct up, 1x90° C bend and 1m vertical duct

Standard Option - Range Hood Colour



Stainless Steel



ILVE COMMERCIAL

MULTI-RESIDENTIAL & HOME BUILDER PRODUCT RANGE

CU89-90 90CM CONCEALED RANGE HOOD

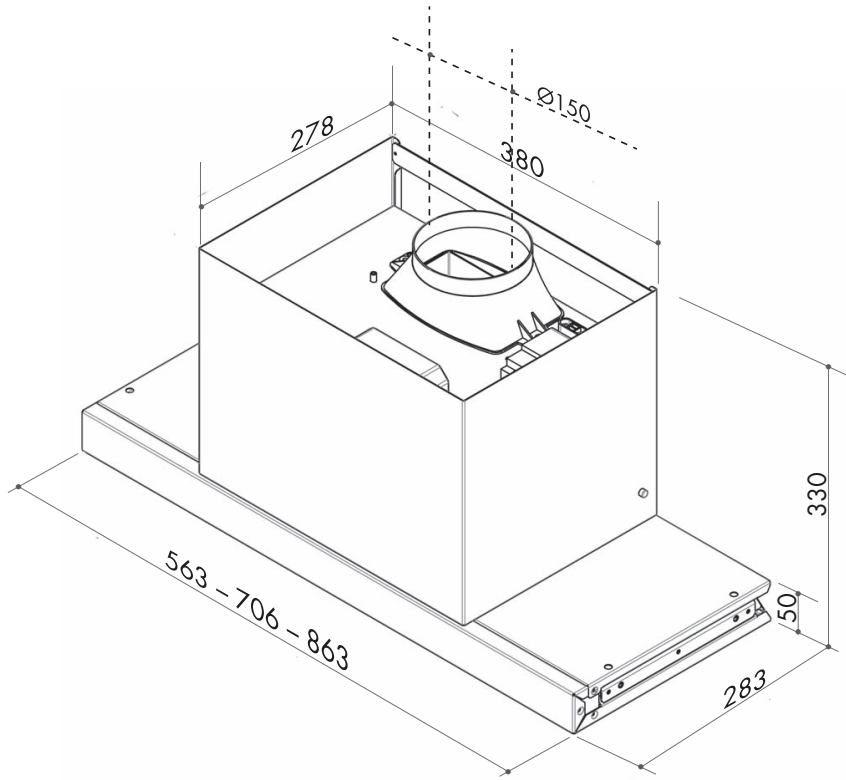

Rangehood
EAN code: 9341584034540 (CU89-90)
 Product Size: 863W X 283D X 330H X
 10 Amp plug

NB: drawings are not to scale —
 they are to be used as a guide only

FOLLOW US:



/ilve_appliances/



/ILVEappliances



/ILVE_appliances



/ILVEappliances

Page 2/2
 16062020

Australia National Telephone Number 1300 MYILVE (694 583) New Zealand Telephone Number 0508 458 369
 ILVE showrooms are open daily from 9am-5pm and Saturdays 10am-4pm

ilve.com.au

NSW & ACT (Head Office)

48-50 Moore Street
 Leichhardt
 F 02 8569 4699

VIC & SA

1211 Toorak Road
 Camberwell
 F 03 9809 2155

QLD

1/42 Cavendish Road
 Coorparoo
 F 07 3397 0850

WA & NT

Unit 10/55 Howe Street
 Osborne Park
 F 08 9201 9188

New Zealand

PO Box 11.160
 Sockburn Christchurch
 F 03 344 5906

DISCLAIMER
 Eurolinx PTY LTD, trading as ILVE Appliances, is continually seeking ways to improve the design specifications, aesthetics and production techniques of its products. As a result alterations to our products and designs take place continually. Whilst every effort is made to produce information and literature that is up to date, this brochure should not be regarded as an infallible guide to the current specifications, nor does it constitute an offer for the sale of any particular product. Product dimensions indicated in our literature is indicative only. Actual product only should be used to define dimension cutouts. Distributors, and retailers are not agents of ILVE Appliances and are not authorized to bind ILVE Appliances by any express or implied undertaking or representation.