

MODEL AGS571



GRANITEK SINGLE-BOWL SINK BLACK OR WHITE
INSET OR UNDERMOUNT



OUR REVOLUTIONARY TECHNOLOGY

Our manufacturing process uses a moulding technology system, meaning Artusi Granitek sinks consist of a substantial and even distribution of its components including within the sink mass. This technology is internationally patented.

Granitek is the name given to our process of bonding granite and acrylic resin. This process results in the highest-quality finish, as it gives greater protection against high temperatures, cracks and chips, and is more resistant to heavy impacts.

CERAMISATION is a method of colouring the granite particles by penetrating the whole mass, through a firing process of heating the material to over 700°C. This ensures the colour can penetrate deeply, reaching particles' core. The result is a significant improvement to resistance against discolouration.

PRODUCT INFORMATION

- Resistance to high temperatures
- Resistance to impacts
- Inset or undermount
- Modern, streamlined appearance
- Easy to clean
- Resistance to surface scratches
- Sink Kit: Space saving siphon, waste and pre-mounted hooks

Features

570x500	550x480	600	
Dimensions (mm)	Built-in hole (mm)	Base	Inset
Anti-bacterial surface	58mm Distance to mixer	200 Bowl depth (mm)	





AGS571B

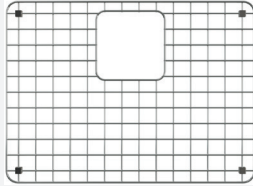

AGS571W

Available accessories:
AGB01304 - Drain Rack

EAN AGS571B: 9347777001566

EAN AGS571W: 9347777001573

AR311018

DISCLAIMER

Eurolinx PTY LTD, is continually seeking ways to improve the design specifications, aesthetics and production techniques of its products. As a result alterations to our products and designs take place continually. Whilst every effort is made to produce information and literature that is up to date, this brochure should not be regarded as an infallible guide to the current specifications, nor does it constitute an offer for the sale of any particular product. Product dimensions indicated in our literature is indicative only. Actual product only should be used to define dimension cut outs. Distributors, and retailers are not agents of Eurolinx and are not authorized to bind Eurolinx by any express or implied undertaking or representation.

FOLLOW US ON: [instagram.com/artusi_appliances](https://www.instagram.com/artusi_appliances)

www.linkedin.com/company/eurolinx-pty-ltd-t-a-llve/

Australia National Telephone Number 1300 (694 583) New Zealand Telephone Number 64 3 344 5913
Artusi showroom hours: Tuesday to Friday - 9am-5pm, Saturday - 10am-4pm, Sunday and Monday - closed
* Melbourne showroom hours: Tuesday to Saturday - 10am-4pm

[artusi.com.au](https://www.artusi.com.au)

NSW & ACT (Head Office)
48-50 Moore Street
Leichhardt
F 02 8569 4699

VIC & SA
1211 Toorak Road
Camberwell
F 03 9809 2155

QLD
1/42 Cavendish Road
Coorparoo
F 07 3397 0850

WA & NT
Unit 10/55 Howe Street
Osborne Park
F 08 9201 9188

TAS
3 Pear Avenue
Derwent Park
F 03 6272 7386

New Zealand
PO Box 11,160
Sockburn Christchurch
F 03 344 5906

MODEL AGS571



GRANITEK SINGLE-BOWL SINK BLACK OR WHITE
INSET OR UNDERMOUNT



TECHNICAL DIAGRAM

TOPMOUNT INSTALLATION

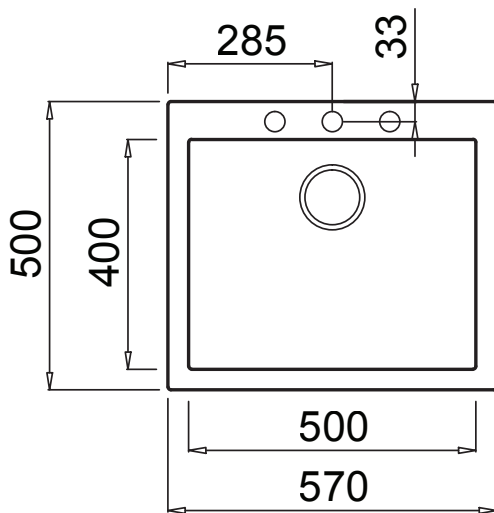

UNDERMOUNT INSTALLATION

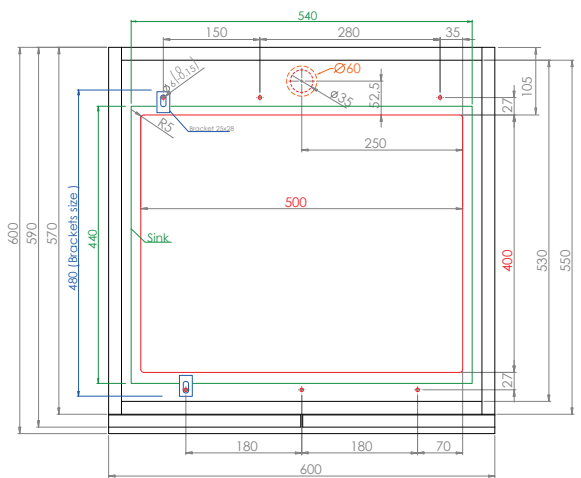
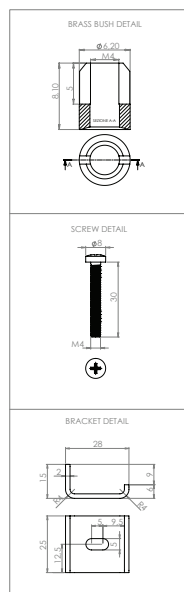

Technical data sheet Quadra105 Under Mount

NB: drawings are not to scale — they are to be used for detailed installation instructions, please refer to user guide.

EAN AGS571B: 9347777001566

EAN AGS571W: 9347777001573

AR311018

DISCLAIMER

Eurolinx PTY LTD, is continually seeking ways to improve the design specifications, aesthetics and production techniques of its products. As a result alterations to our products and designs take place continually. Whilst every effort is made to produce information and literature that is up to date, this brochure should not be regarded as an infallible guide to the current specifications, nor does it constitute an offer for the sale of any particular product. Product dimensions indicated in our literature is indicative only. Actual product only should be used to define dimension cut outs. Distributors, and retailers are not agents of Eurolinx and are not authorized to bind Eurolinx by any express or implied undertaking or representation.

AGS571 single-bowl sink | INSET or UNDERMOUNT
BLACK or WHITE GRANITEK

FOLLOW US ON: [instagram.com/artusi_appliances](https://www.instagram.com/artusi_appliances)

www.linkedin.com/company/eurolinx-pty-ltd-t-a-llve/

Australia National Telephone Number 1300 (694 583) New Zealand Telephone Number 64 3 344 5913
Artusi showroom hours: Tuesday to Friday - 9am-5pm, Saturday - 10am-4pm, Sunday and Monday - closed
* Melbourne showroom hours: Tuesday to Saturday - 10am-4pm

[artusi.com.au](https://www.artusi.com.au)

NSW & ACT (Head Office)
48-50 Moore Street
Leichhardt
F 02 8569 4699

VIC & SA
1211 Toorak Road
Camberwell
F 03 9809 2155

QLD
1/42 Cavendish Road
Coorparoo
F 07 3397 0850

WA & NT
Unit 10/55 Howe Street
Osborne Park
F 08 9201 9188

TAS
3 Pear Avenue
Derwent Park
P 03 6272 7386

New Zealand
PO Box 11,160
Sockburn Christchurch
F 03 344 5906