

# MODEL AGS1162



GRANITEK DOUBLE-BOWL SINK WITH DRAINER  
BLACK OR WHITE INSET



## OUR REVOLUTIONARY TECHNOLOGY

Our manufacturing process uses a moulding technology system, meaning Artusi Granitek sinks consist of a substantial and even distribution of its components including within the sink mass. This technology is internationally patented.







Granitek is the name given to our process of bonding granite and acrylic resin. This process results in the highest-quality finish, as it gives greater protection against high temperatures, cracks and chips, and is more resistant to heavy impacts.

CERAMISATION is a method of colouring the granite particles by penetrating the whole mass, through a firing process of heating the material to over 700°C. This ensures the colour can penetrate deeply, reaching particles' core. The result is a significant improvement to resistance against discolouration.

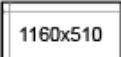
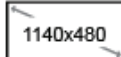
## PRODUCT INFORMATION

- Sink Kit: Space saving siphon, waste and pre-mounted hooks

**Features**

 1160x510 Dimensions (mm)	 1140x480 Built-in hole (mm)	 800 Base	 Inset
 Anti-bacterial surface	 Reversible	 Rectangular overflow	 200 Bowl depth (mm)





AGS1162B



AGS1162W

Available accessories:

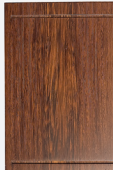
- ARI01300 - Drain Rack
- ATL11600 - Wooden Chopping Block

EAN AGS1162B: 9347777001467

EAN AGS1162W: 9347777001474

AR311018

## DISCLAIMER

Eurolinx PTY LTD, is continually seeking ways to improve the design specifications, aesthetics and production techniques of its products. As a result alterations to our products and designs take place continually. Whilst every effort is made to produce information and literature that is up to date, this brochure should not be regarded as an infallible guide to the current specifications, nor does it constitute an offer for the sale of any particular product. Product dimensions indicated in our literature is indicative only. Actual product only should be used to define dimension cut outs. Distributors, and retailers are not agents of Eurolinx and are not authorized to bind Eurolinx by any express or implied undertaking or representation.

**FOLLOW US ON:**  [instagram.com/artusi\\_appliances](https://www.instagram.com/artusi_appliances)

 [www.linkedin.com/company/eurolinx-pty-ltd-t-a-llve/](https://www.linkedin.com/company/eurolinx-pty-ltd-t-a-llve/)

Australia National Telephone Number 1300 (694 583) New Zealand Telephone Number 64 3 344 5913  
Artusi showroom hours: Tuesday to Friday - 9am-5pm, Saturday - 10am-4pm, Sunday and Monday - closed  
\* Melbourne showroom hours: Tuesday to Saturday - 10am-4pm

[artusi.com.au](https://www.artusi.com.au)

**NSW & ACT (Head Office)**  
48-50 Moore Street  
Leichhardt  
F 02 8569 4699

**VIC & SA**  
1211 Toorak Road  
Camberwell  
F 03 9809 2155

**QLD**  
1/42 Cavendish Road  
Coorparoo  
F 07 3397 0850

**WA & NT**  
Unit 10/55 Howe Street  
Osborne Park  
F 08 9201 9188

**TAS**  
3 Pear Avenue  
Derwent Park  
F 03 6272 7386

**New Zealand**  
PO Box 11.160  
Sockburn Christchurch  
F 03 344 5906

# MODEL AGS1162



GRANITEK DOUBLE-BOWL SINK WITH DRAINER  
BLACK OR WHITE INSET



## TECHNICAL DIAGRAM

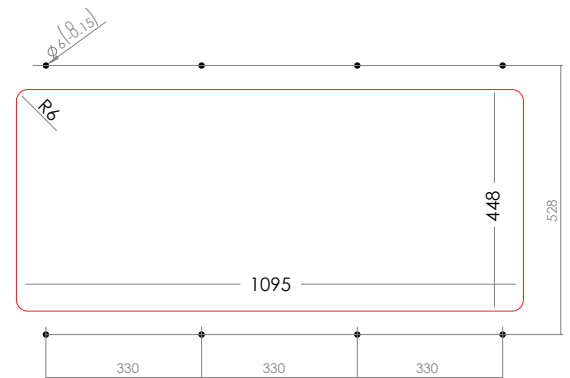
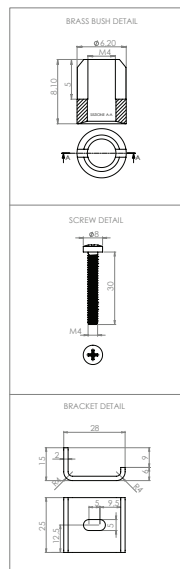
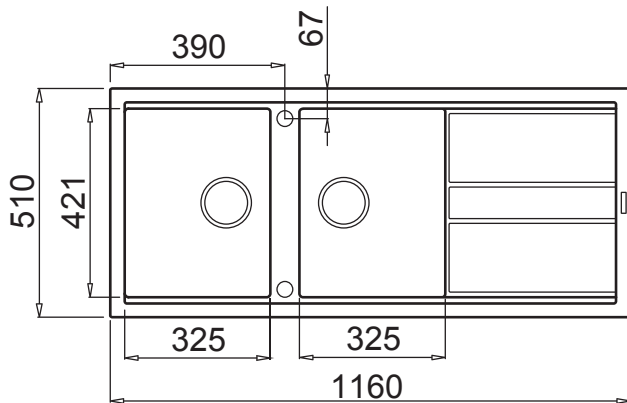

Technical data sheet Best500 Under Mount

NB: drawings are not to scale — they are to be used for detailed installation instructions, please refer to user guide.

**EAN AGS1162B: 9347777001467**

**EAN AGS1162W: 9347777001474**

AR311018

### DISCLAIMER

Eurolinx PTY LTD, is continually seeking ways to improve the design specifications, aesthetics and production techniques of its products. As a result alterations to our products and designs take place continually. Whilst every effort is made to produce information and literature that is up to date, this brochure should not be regarded as an infallible guide to the current specifications, nor does it constitute an offer for the sale of any particular product. Product dimensions indicated in our literature is indicative only. Actual product only should be used to define dimension cut outs. Distributors, and retailers are not agents of Eurolinx and are not authorized to bind Eurolinx by any express or implied undertaking or representation.

AGS1162 Double-bowl sink with drainer | INSET  
BLACK or WHITE GRANITEK

**FOLLOW US ON:** [instagram.com/artusi\\_appliances](https://www.instagram.com/artusi_appliances)

[www.linkedin.com/company/eurolinx-pty-ltd-t-a-lve/](https://www.linkedin.com/company/eurolinx-pty-ltd-t-a-lve/)

Australia National Telephone Number 1300 (694 583) New Zealand Telephone Number 64 3 344 5913  
Artusi showroom hours: Tuesday to Friday - 9am-5pm, Saturday - 10am-4pm, Sunday and Monday - closed  
\* Melbourne showroom hours: Tuesday to Saturday - 10am-4pm

[artusi.com.au](https://www.artusi.com.au)

**NSW & ACT (Head Office)**  
48-50 Moore Street  
Leichhardt  
F 02 8569 4699

**VIC & SA**  
1211 Toorak Road  
Camberwell  
F 03 9809 2155

**QLD**  
1/42 Cavendish Road  
Coorparoo  
F 07 3397 0850

**WA & NT**  
Unit 10/55 Howe Street  
Osborne Park  
F 08 9201 9188

**TAS**  
3 Pear Avenue  
Derwent Park  
F 03 6272 7386

**New Zealand**  
PO Box 11.160  
Sockburn Christchurch  
F 03 344 5906